



Vegetable Preparation Machine

RG-50S

Food Preparation Machines - Made in Sweden since 1941 

 2 kg /min   80 /day 



halde.com

Ergonomics in all stages

The RG-50S is the most compact vegetable preparation machine from HALLDE. It is developed to suite smaller kitchens and the compact design makes RG-50S easy to put away and bring back when needed. The machine is a table top and can be used directly on the kitchen workbench. RG-50S pusher plate is swung up in a bow shape angle. This together with the low height makes for a better working posture.

Safe and quick top ups

Thanks to the automatic start and stop function the machine stops as soon as the pusher plate is swung up. When it is swung back the machine restarts and you can continue working. A clear advantage, particularly when larger volumes are involved.

Double safety against unprotected blades

If the feed cylinder is removed the power is cut. Thanks to this double security there is no risk of the machine starting with an unprotected blade.

Developed for the best hygiene

The RG-50S is manufactured solely from hygiene certified material. The machine has smooth surfaces, rounded edges and has no unnecessary recesses where food might penetrate and get stuck.

Easy cleaning

For quick cleaning, all loose parts are simple to remove for easy rinsing of the machine. The feed cylinder is removable and can be washed in a dishwasher.

Only the best material

The machine base is made of robust ABS-plastic, the feed cylinder and pusher plate are made of strong polycarbonate. Only top quality stainless steel is used to manufacture the cutting tool knife blades.

Lightweight and easy to move

The small size of the machine gives several advantages. It does not take up a lot of space in the kitchen. And it is easy to move, something which is helped by the generously sized handles on the sides.

Highest possible reliability

The powerful motor has a high starting and running torque and powers the cutting tool via a self-tensioning belt. The motor speed is geared down which makes the RG-50S an exceptionally reliable machine – irrespective of the products you are preparing.

Cutting tools with complete register

Our wide range of cutting tools means the RG-50S can handle every conceivable task. You choose the cutting tool you need to improve efficiency throughout the kitchen. The RG-50S slices, grates/shreds, cuts juliennes and crimping slices – everything from firm to soft products.

Always perfect cutting results

The rotation speed of the cutting tools is optimised for cutting fine and even slices as efficiently as possible. The blades are purposely sharpened to avoid inertia or the edge breaking off.



Accessories that simplify life in your kitchen

• Recommended Cutting tool pack

- 2-pack Cutting Tools:
 - Slicer 4 mm
 - Grater/Shredder 4 mm
- 4-pack Cutting Tools:
 - Slicer 2 mm
 - Slicer 4 mm
 - Grater/Shredder 4 mm
 - Julienne Cutter 2x2 mm



• Cleaning brushes in two sizes

Used for cleaning machines and cutting tools. Both have coarse bristles that are particularly effective for cleaning Dicing Grids and Julienne Cutters.



• Wall rack for Cutting Tools

Provides space for three cutting tools and a quick overview of the entire range, saving space and making handling safe and comfortable – an effective way of protecting the edges of the blades from unnecessary wear.

Result- and inspiration videos ➔



High quality cutting tools for best results

* Use Cutting tools from RG-100

All cutting tools are dishwasher safe. All knives and plates are made of stainless steel.

 Replaceable knives / plates.



Slicer

1, 2, 4, 6 mm

*  0.5, 1.5, 3, 5, 7, 8, 9, 10 mm

Slices firm and soft vegetables, fruits, mushrooms etc.



Fine Cut Slicer

*  15 mm

Slices firm and soft vegetables, fruits, mushrooms etc. Dices when combined with a suitable Dicing Grid.



Soft Slicer

*  8, 10, 12, 15 mm

Slices soft vegetables, fruits, mushrooms etc. Preferably used when dicing soft products, in combination with a suitable Dicing Grid.

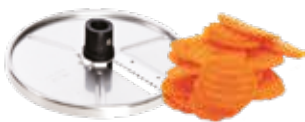

Crimping Slicer

4 mm

*  2, 3, 5, 6 mm

Cuts decorative rippled slices of beetroot, cucumber, carrots, etc.



Julienne Cutter

2x2, 4x4 mm

*  2x6, 3x3 mm

Cuts julienne of firm products for soups, salads, stews, decorations etc. Suitable to cut slightly curved potato chips.



NEW!

Serrated Slicer

*  10 mm

Cut proteins such as cooked chicken, salami and halloumi.



Grater/Shredder

2, 4, 6 mm.

*  1.5, 3, 4.5, 8, 10 mm

Grates carrots and cabbage for raw salads. Grates nuts, almonds and dry bread. Grater 6 or 8 mm is commonly used for grating cheese for pizza and when shredding cabbage.

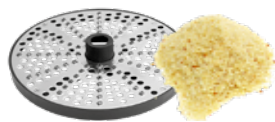

Fine Grater

* 

For finely grating products such as raw potatoes for Swedish potato pancakes and bread for making breadcrumbs.



Hard Cheese Grater

* 

Ideal for grating hard cheese such as parmesan. Produces a somewhat coarser grate than the Fine Grater, Extra fine.



Fine Grater, Extra fine

* 

Grates products very finely, such as black radish grated for purée and potatoes for mashing.





Machine

- Motor: 1.0 kW. One speed. 220-240 V, 1-phase, 50-60 Hz.
- Transmission: Toothed belt.
- Safety system: Two safety switches.
- Degree of protection machine: IP34.
- Power supply socket: Earthed, 1-phase, 10 A.
- Fuse: 10 A, delayed action fuse.
- Sound level LpA (EN31201): 76 dBA.
- Magnetic field: Less than 0.1 microtesla.

Materials

- Machine base: ABS-plastic.
- Knife chamber: ABS-plastic.
- Feeder: Polycarbonate and polyamide.
- Ejector plate: Acetal.
- Cutting tool disks: Stainless steel.
- Cutting tool knives: Stainless steel.

Feeder

- Feed cylinder: Volume 0.9 litre.
Height 185 mm. Diameter 170 mm.
- Feed tube with internal diameter 53 mm.

Cutting Tools

- Cutting tool diameter: 185 mm.
- Speed: 500 rpm (50 Hz).

Type of preparation

- Slices, grates, shreds, cuts julienne and crimping slices.
- Processes vegetables, fruit, dry bread, cheese, nuts, mushrooms etc.

Users

- Restaurants, shop kitchens, cafés, bakeries, diet kitchens, retirement homes, schools, fast food outlets, day care centres, salad bars, etc.

Net weights

- Machine base: 7 kg.
- Cutting Tools: 0.3 kg.

Standards

- Directive: Visit hallde.com and select product and Certification.

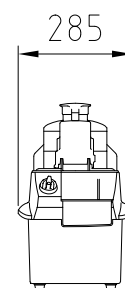
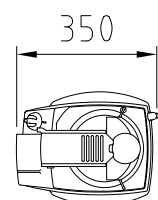
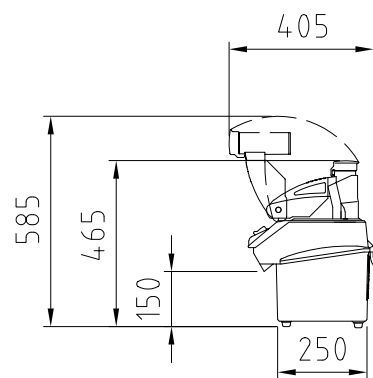

Food Preparation Machines
Made in Sweden since 1941

FOLLOW US!

Look at videos, get tips,
inspiration and education!

